

BRYSTON
BP2-MM MM Phono Preamplifier

Owner's Manual



Important Safety Instructions





The lightning flash with arrowhead symbol within an equilateral triangle, is intended to alert the user to the presence of un-insulated “dangerous voltage” within the product’s enclosure that may be of sufficient magnitude to constitute a risk of electric shock to persons.



The exclamation point within an equilateral triangle is intended to alert the user to the presence of important operating and maintenance (servicing) instructions in the literature accompanying the product.

1. Read these instructions.
2. Keep these instructions.
3. Heed all warnings.
4. Follow all instructions.
5. Do not use this apparatus near water.
6. Clean only with dry cloth.
7. Do not block any ventilation openings. Install in accordance with the manufacturer’s instructions.
8. Do not install near any heat sources such as radiators, heat registers, stoves, or other apparatus (including amplifiers) that produce heat.
9. Do not defeat the safety purpose of the polarized or grounding-type plug. A polarized plug has two blades with one wider than the other. A grounding type plug has two blades and a third grounding prong. The wide blade or the third prong are provided for your safety. If the provided plug does not fit into your outlet, consult an electrician for replacement of the obsolete outlet.
10. Protect the power cord from being walked on or pinched particularly at plugs, convenience receptacles, and the point where they exit from the apparatus.

11. Only use attachments/accessories specified by the manufacturer.
12.  Use only with the cart, stand, tripod, bracket, or table specified by the manufacturer, or sold with the apparatus. When a cart is used use caution when moving the cart/apparatus combination to avoid injury from tip-over.
13.  Any terminals marked with the preceding symbol are HAZARDOUS LIVE and any wiring connected to these terminals must be installed by an INSTRUCTED PERSON or with ready-made leads or cords.
14. Unplug this apparatus during lightning storms or when unused for long periods of time.
15. Refer all servicing to qualified service personnel. Servicing is required when the apparatus has been damaged in any way, such as power-supply cord or plug is damaged, liquid has been spilled or objects have fallen into the apparatus, the apparatus has been exposed to rain or moisture, does not operate normally, or has been dropped.

WARNING: TO REDUCE THE RISK OF FIRE OR ELECTRIC SHOCK, DO NOT EXPOSE THIS APPARATUS TO RAIN OR MOISTURE. DO NOT EXPOSE THIS EQUIPMENT TO DRIPPING OR SPLASHING AND ENSURE THAT NO OBJECTS FILLED WITH LIQUIDS, SUCH AS VASES, ARE PLACED ON THE EQUIPMENT. TO COMPLETELY DISCONNECT THIS EQUIPMENT FROM THE AC MAINS, DISCONNECT THE POWER SUPPLY CORD PLUG FROM THE AC RECEPTACLE. THE MAINS PLUG OF THE POWER SUPPLY CORD SHALL REMAIN READILY OPERABLE.

BRYSTON LIMITED WARRANTY

Bryston analog audio products are warranted to be free from manufacturing defects for twenty (20) years from the original date of manufacture. The warranty includes parts and labour. Bryston digital products and cables are warranted for five years from the original date of manufacture. The warranty includes parts and labour.

Bryston products having motorized moving parts, excluding motorized volume controls, are warranted for three years from the original date of manufacture. The warranty includes parts and labour.

Bryston will remedy the problem by repair or replacement, as we deem necessary, to restore the product to full performance. Bryston will pay return shipping only for the full length of the specific product’s warranty.

In the event of a defect or malfunction, contact Bryston’s repair centers for return authorization. Products must be returned using original packaging material only. Packing material may be purchased from Bryston if necessary. This warranty is considered void if the defect, malfunction or failure of the product or any component part was caused by damage (not resulting from a defect or malfunction) or abuse while in the possession of the customer. Tampering by persons other than factory authorized service personnel or failure to fully comply with Bryston operating instructions voids the warranty. This warranty gives you specific legal rights and you may also have other rights which may vary from province to province and country to country. As of 2006-02-22 Bryston will only warranty Bryston products purchased through authorized Bryston dealers. Bryston products with a date code of 0608 or higher (date code format is “yyww”, where “yy” is the two least significant digits of the year and “ww” is the week of the year) must be accompanied by a copy of the bill-of-sale from a Bryston authorized dealer to qualify for warranty service. The warranty is transferable from the original owner to a subsequent owner as long as a copy of the bill-of-sale from the original authorized Bryston dealer accompanies the re-sale. The copy of the bill of sale to any subsequent owner need ONLY include the Name of the Bryston Authorized Dealer and the Model and Serial number of the Bryston product. The warranty will only be honored in the country of the original purchase unless otherwise pre-authorized by Bryston.

BRYSTON SERVICE in CANADA:

Postal address: P.O. BOX 2170, Stn. Main
PETERBOROUGH, ONTARIO
CANADA K9J 7Y4

Courier address: 677 NEAL DRIVE
PETERBOROUGH, ONTARIO
CANADA K9J 6X7

PHONE: 705-742-5325
FAX: 705-742-0882
E-mail: cdnser@bryston.com

BRYSTON SERVICE in the USA:

79 COVENTRY ST., Suite 5
NEWPORT, VERMONT
U.S.A. 05855-2100

PHONE: 802-334-1201
FAX: 802-334-6658
E-mail: usaser@bryston.com

BRYSTON SERVICE outside Canada and the USA:

contact your local distributor or

CHECK OUR WEB SITE: www.bryston.com
E-MAIL BRYSTON DIRECTLY: cdnser@bryston.com
FAX BRYSTON DIRECTLY: 01-705-742-0882
PHONE BRYSTON DIRECTLY: 01-705-742-5325

Table of Contents

General.....	4
Welcome	4
Description	4
Features	4
Shipping Box and Packing Material.....	4
Installation and Usage	4
Placement.....	4
Connecting to Power Supply	4
Connecting to Audio System	4
Cartridge Loading.....	5
Front and Rear Panels	6
Specifications	7
Dimensions.....	7

General

Welcome

Thank you for your purchase of a Bryston BP2-MM moving magnet phono preamplifier. Powered by a Bryston PS-3, the BP2-MM is an extremely high performance, yet compact and practical active gain stage for your vinyl playback system with moving magnet cartridge. Our customers are a valuable resource to whom we turn for a measure of success. We welcome your comments on the Bryston BP2-MM.

Description

The Bryston BP2-MM is a phono preamplifier designed to amplify signals from a moving magnet phono cartridge to line-level voltage and is intended for use with moving magnet cartridges having output of approximately 5 mV or more.

Features

Bryston BP2-MM includes the following features:

- High quality / low distortion active gain stage
- Selectable loading between 100pF and 400pF
- Powered by external Bryston PS-3 power supply
- Superb RIAA accuracy
- All steel chassis and top cover.

Shipping Box and Packing Material

Please keep the original shipping box and all packing material. This will ensure the BP2-MM is protected in future transport. In the unlikely event you have a problem and must return it for service, you must use the proper packing material. Ship the

unit only in the original packing material, as the unit is not insurable by carriers otherwise. Replacement packing materials consisting of a shipping carton with plastic foam inserts is available from Bryston for a small fee.

Installation and Usage

Placement

The BP2-MM is a cool-running gain stage and can be placed in the position most convenient to your circumstance. The nature of the product is to amplify very low level signals, so some care in placement is worth while to maximize performance. Do not place the unit next to electronics known to radiate a high amount of noise. When possible, do not stack on top of Bryston power supply.

Connecting to Power Supply

The BP2-MM must be used with a Bryston power supply model PS-3 or MPS-2. Only the XLR-6 terminated interconnect included with the BP2-MM should be used to connect the BP2-MM to the power supply. Insert the female end of the cable into the BP2-MM and the male end to the approved power supply. A secure connection is established when you hear the cable click into place.

Connecting to Audio System

The input of the BP2-MM accepts a left/right pair of RCA cables from your turntable's cartridge output.

If your turntable has a ground screw, connect a wire from this to the ground screw of the BP2-MM to eliminate humming due to ground loops.

Output from the BP2-MM can then be sent to a line-

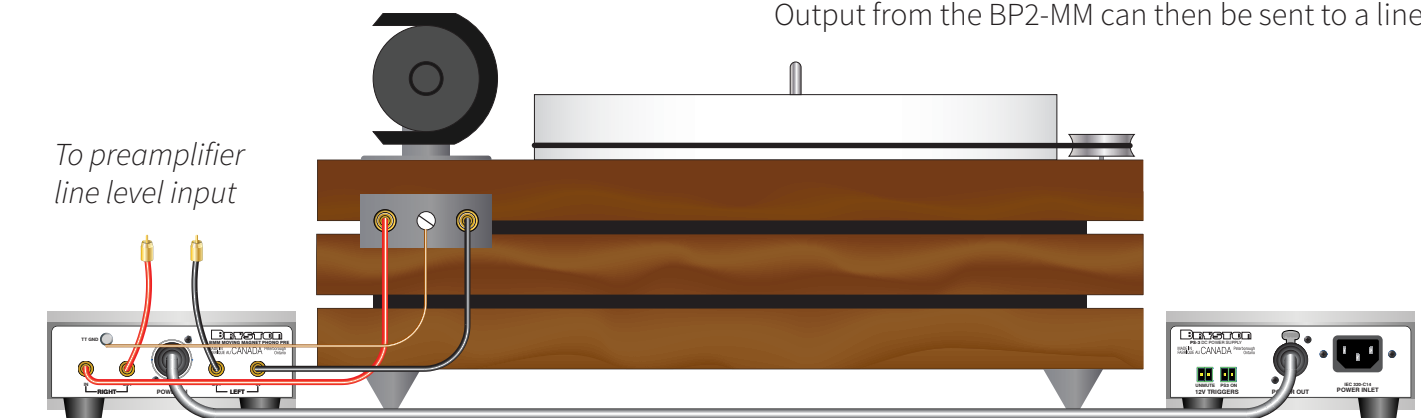

BP2-MM Moving Magnet Phono Preamp

level analog preamplifier using RCA cables.

Cartridge Loading

Some moving magnet cartridges perform best when presented with a capacitive load. The BP2-MM offers four settings for capacitive loading which can be set internally with jumpers. The desired loading for your cartridge may be found in the documentation included with the cartridge. Note that the attached interconnects also present some capacitive load. Consult the documentation included with your interconnect for specifics of your model.

To set additional loading, disconnect the BP2-MM from the power supply. Remove the top by unscrewing each of 4 screws (2 on each side) using a T-8 Torx screwdriver. Lift the top straight off. Locate the jumpers for each channel highlighted in green below and labeled JC1 and JC2 respectively.

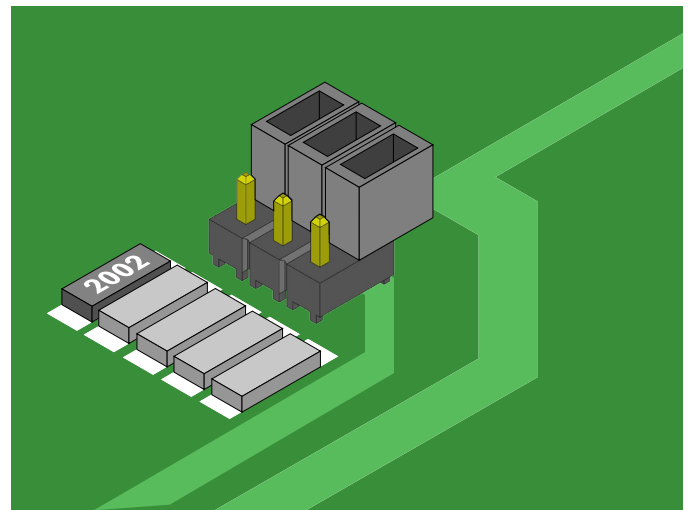
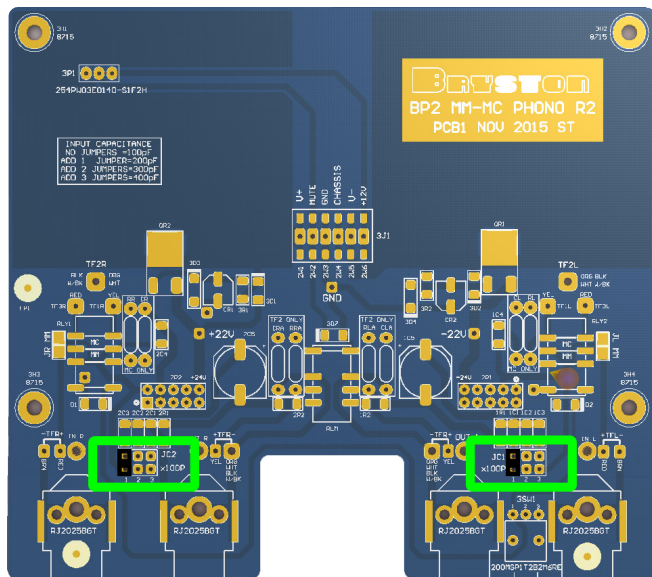

One channel shown. No jumpers connected. loading capacitance is 100pF.

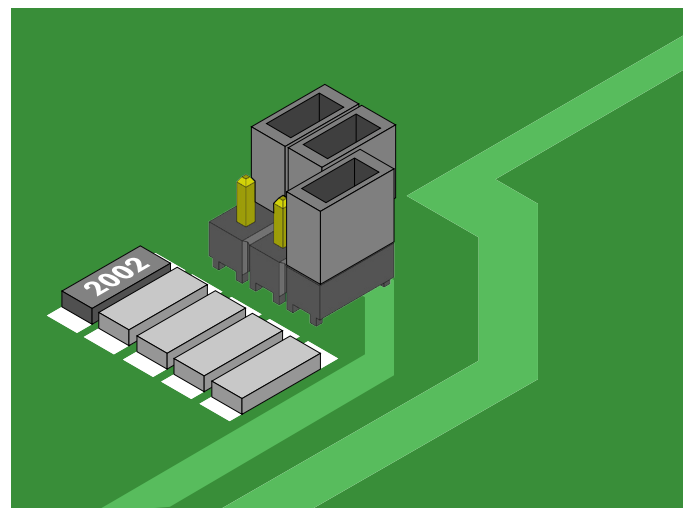

One channel shown. One jumper connected adding capacitance to form total of 200pF capacitance.

The minimum value is 100pF and maximum is 400pF. No jumpers should be connected for 100pF value. Adding jumpers will increase capacitance in 100pF increments. Capacitance is set per channel. Each channel should be set identically to ensure no difference in tonal balance between left and right channels.

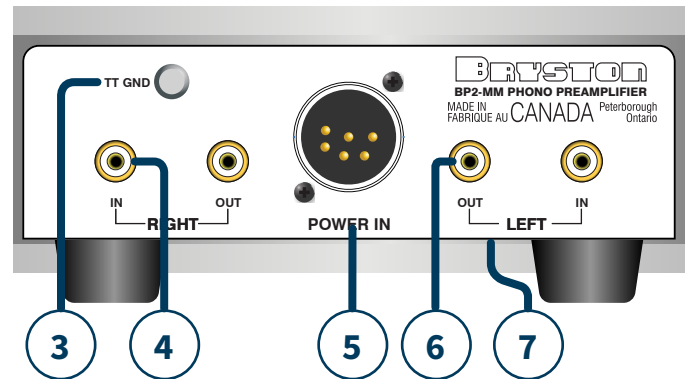
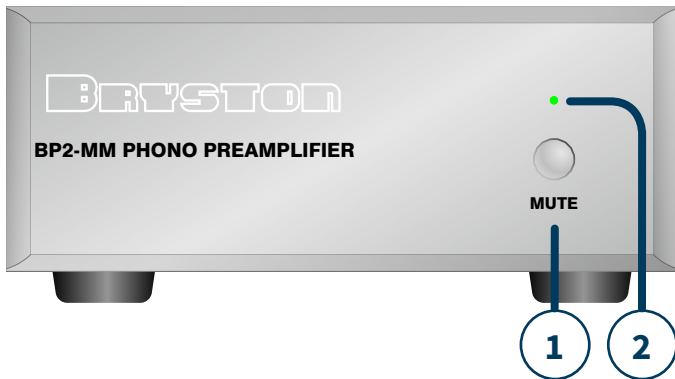

Front and Rear Panels

1. Mute Switch

Push button switch to mute audio signal from the BP2-MM. Press again to unmute. When in mute, devices connected to the PS3 trigger output are placed in standby mode.

2. Power LED

The LED lights green (optionally blue) when the BP2-MM is operating normally and unmuted. When in mute, the LED is red.

3. Ground Screw

Establish a secure connection to the ground screw on your turntable when available to reduce the possibility of hum due to ground voltage differential between the turntable and the phono preamplifier. This is usually done with a cable featuring a small spade connector on each end. The connector will accept stripped bare wire, or with spade lug or banana plug connector

4. Audio Input

Connect audio to your BP2-MM from your turntable output through the left/right input jacks.

5. DC Power Inlet

Connect the BP2-MM to your Bryston PS-3 DC Power Supply using only the included cable to apply power to the BP2-MM.

6. Audio Output

Connect the BP2-MM to your analog line-level preamplifier input using the left/right output jacks.

7. Data Plate

The data plate is located underneath the unit and lists the model number, voltage requirements, serial number, and date code. Ensure that the voltage and line frequency conform to your locality before powering the unit on.

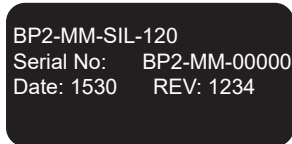

BP2-MM Moving Magnet Phono Preamp

Specifications

Frequency Response 20 Hz - 20kHz \pm 0.1 dB
(using RIAA Inverse EQ)

Gain 41 dB @ 1kHz

Sensitivity 5 mV

Distortion 0.005% THD+N or IMD
20Hz to 20kHz

Noise -80dB ref. 5 mV input
A Weighted

Dimensions

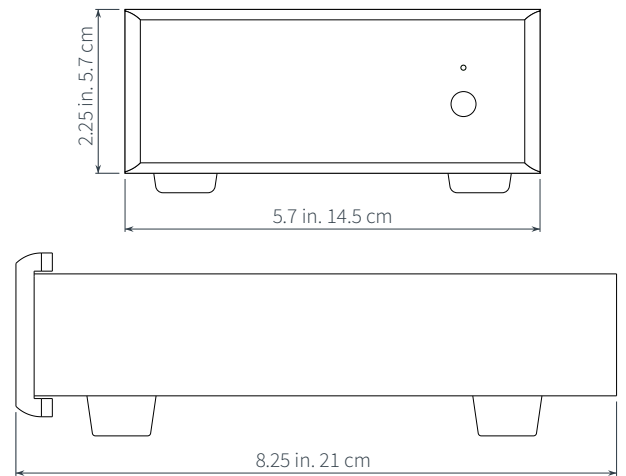

Bryston Limited | 677 Neal Drive | Peterborough, Ontario K9J 6X7
Canada | Phone: 705-742-5325 | www.bryston.com