

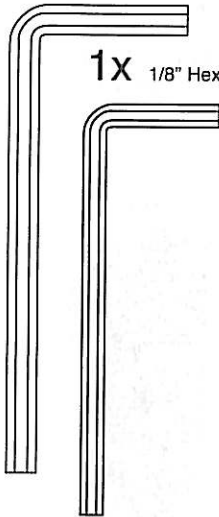

# SYNERGY RACK MOUNT KIT TO ACCOMMODATE DOOR

1x 5/32" Hex Key - (400-080)



1x 1/8" Hex Key - (400-070)

12x

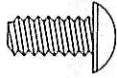

(300-485)  
1/2" Button Head  
Screw

2x



(301-360)  
Mounting Screw

8x

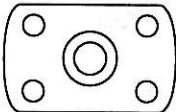

(300-560) - Flat Nut

## Limited Warranty

For five full years Salamander Designs Ltd. will repair or replace, at our option, any product defective in materials or craftsmanship. Salamander Designs Ltd. will not be responsible for any damage to or destruction of other equipment consequential to our equipment failure. Defective product must be given Return Authorization and is to be returned to the factory prepaid, in the original carton and packing material. Any damage incurred in a shipment not in original packaging shall be the responsibility of the owner. Warranty repairs will be returned prepaid, via UPS within the continental U.S.A. only.

[www.SalamanderDesigns.com](http://www.SalamanderDesigns.com)  
800-535-5659

Doc No. 500-455 / v11.10 ©2010 Salamander Designs Ltd.

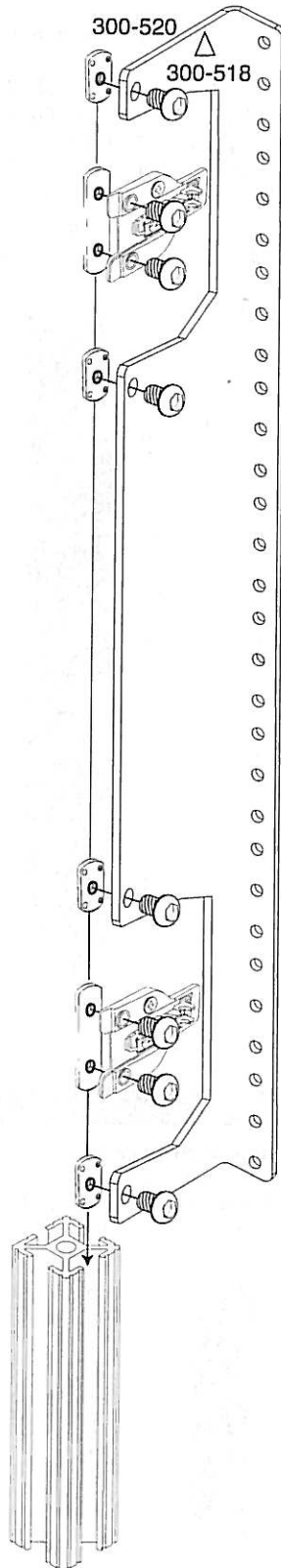

### OPTION: INSTALLING GEAR FORWARD

Rack rails may also be installed with the flange forward in applications the door is not desired and additional cabinet depth is needed.

- A. Place the 1/2" Button Head Screw (300-485) in the holes of rack mount rail and hinge bracket and loosely screw to Flat-nut (300-560).

△ Note: Rackmount brackets that have a triangle must locate at the top.

- B. Slide Rack Mount Rail into position with the Flat Nuts sliding into the channel as shown. After bracket is in position tighten all screws with hex key.

- C. Snap door onto hinge bases align top and bottom gap and tighten.

For 15 and 21U rails:

- D. Install header panel at the top same location of rack mount.

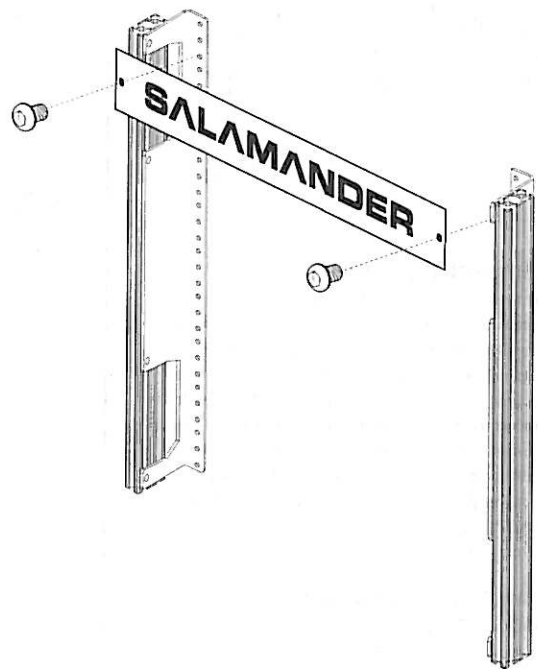



# SYNERGY RACK MOUNT

1x 5/32" Hex Key - (400-080)

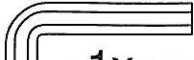

1x 1/8" Hex Key - (400-070)

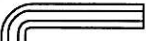

6x



(300-518)  
3/8" Button Head Screw

8x

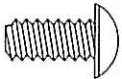

(300-485)  
1/2" Button Head Screw

12x

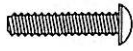

(301-360)  
Mounting Screw

8x

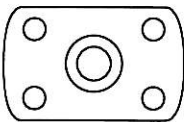

(300-560) - Flat Nut

4x

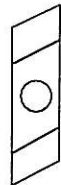

(300-565)  
Drop-In Nut

## OPTION: INSTALLING GEAR FORWARD

Rack rails may also be installed with the flange forward in applications the door is not desired and additional cabinet depth is needed.

### A For Installing in Synergy Cabinets:

Place the 1/2" Button Head Screw (300-485) in the holes of each bracket and attach loosely with Flat Nut. Note: For assembled cabinets use the Drop-In Nut in place of the Flat Nut.

### For Installing in Chameleon Cabinets:

Use the Drop-In Nuts (300-565) and the shorter 3/8" Button Head Screws (300-518).

**B** Insert Flat Nuts or Drop-In Nuts into the channels (Use the Front Side Channel for Chameleon). Secure screws with Hex Key.

**C** Use standard 10-32 mounting screws to mount equipment on rack rails.

**D** For 15U & 21U Rails, attach header panel at the top of the rack rail.

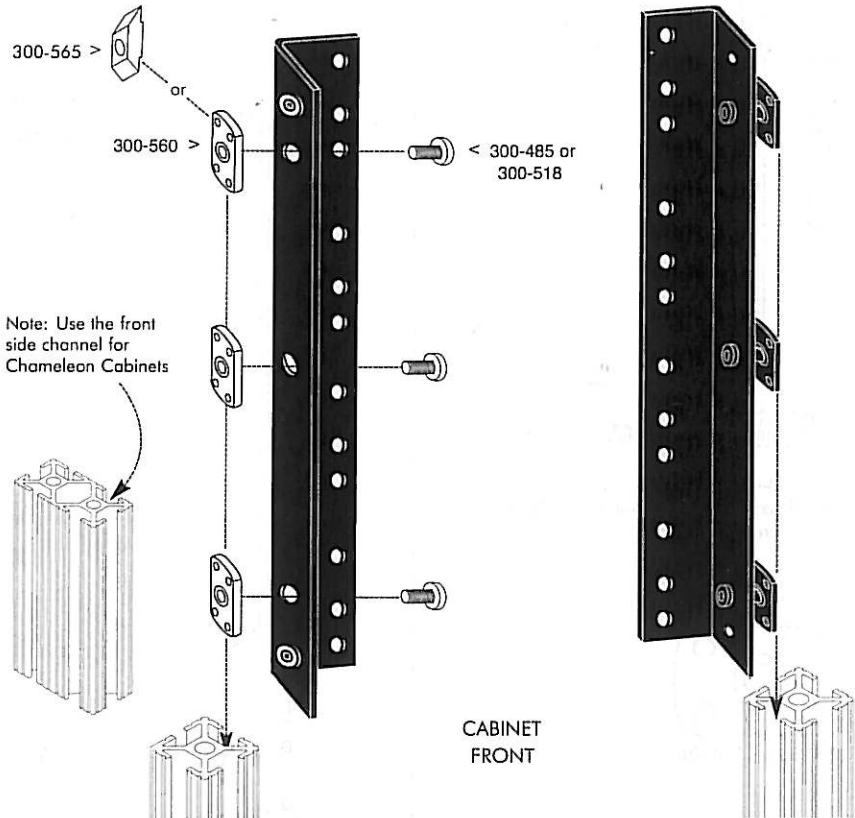

## NOTES

### Installing Gear Forward

Rack rails may also be installed with the flange forward in applications the door is not desired and additional cabinet depth is needed.

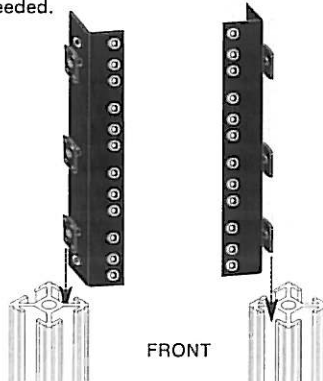

For Small Segment Use Behind Door  
Install brackets away from door hinges.

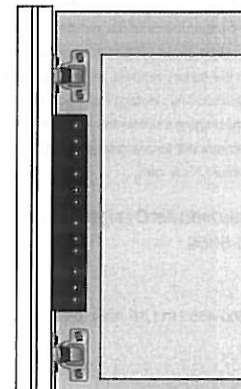

## Limited Warranty

For five full years Salamander Designs Ltd. will repair or replace, at our option, any product defective in materials or craftsmanship. Salamander Designs Ltd. will not be responsible for any damage to or destruction of other equipment consequential to our equipment failure. Defective product must be given Return Authorization and is to be returned to the factory prepaid, in the original carton and packing material. Any damage incurred in a shipment not in original packaging shall be the responsibility of the owner. Warranty repairs will be returned prepaid, via UPS within the continental U.S.A. only.

[www.SalamanderDesigns.com](http://www.SalamanderDesigns.com)  
800-535-5659

Doc No. 500-455 / v11.10 ©2010 Salamander Designs Ltd.